

Pannello anteriore (vista frontale)

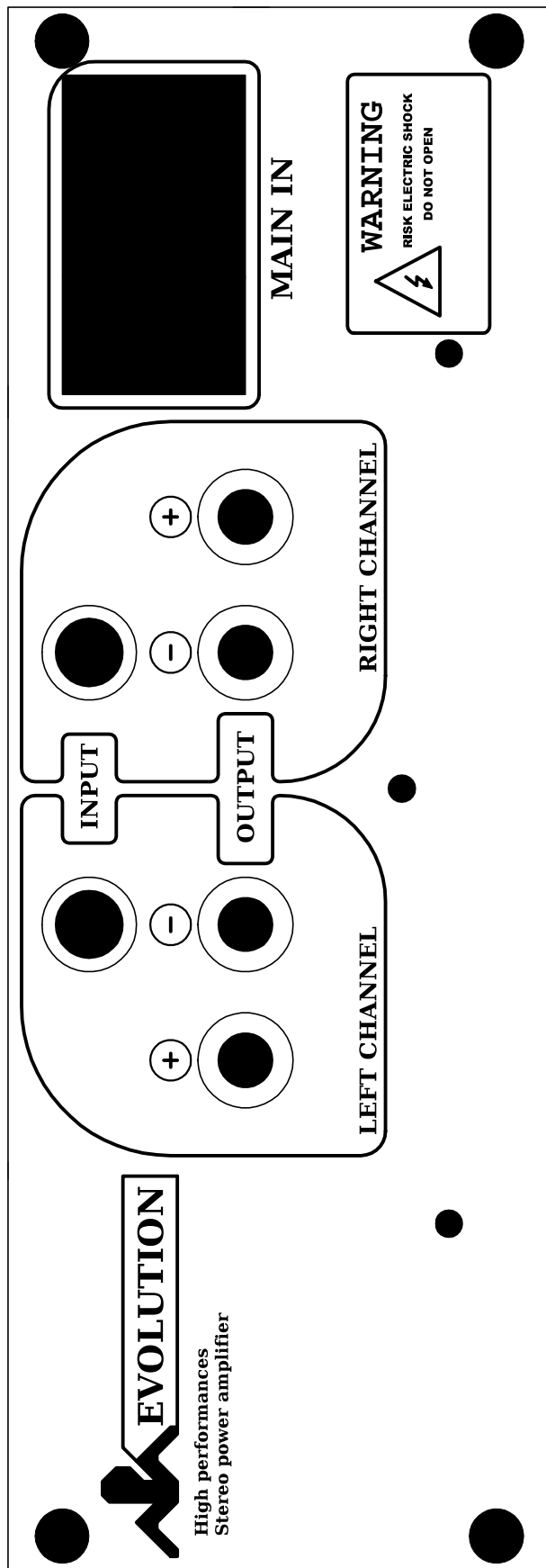

Pannello posteriore (vista retro mobile)
Serigrafia

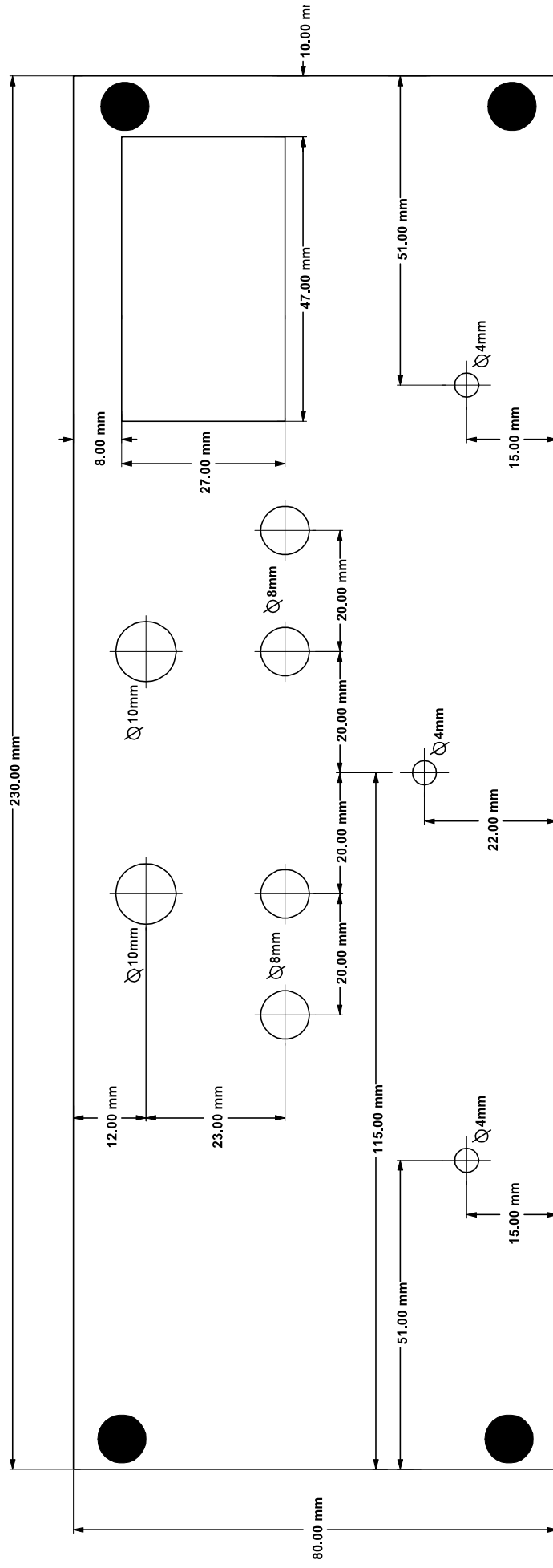

Pannello posteriore (vista retro mobile)
Piano foratura

280,00 mm

Pannello laterale SX (vista laterale) Piano foratura fori passanti



Lato superiore



Fronte

80,00 mm

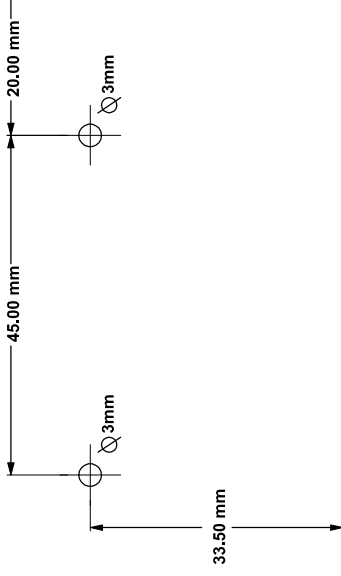

Pannello laterale DX (vista laterale) Piano foratura fori passanti



Lato superiore



Fronte

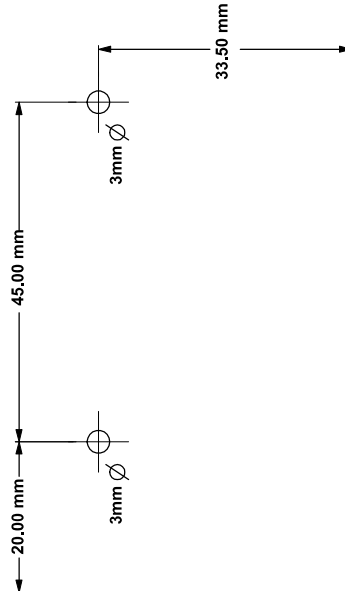

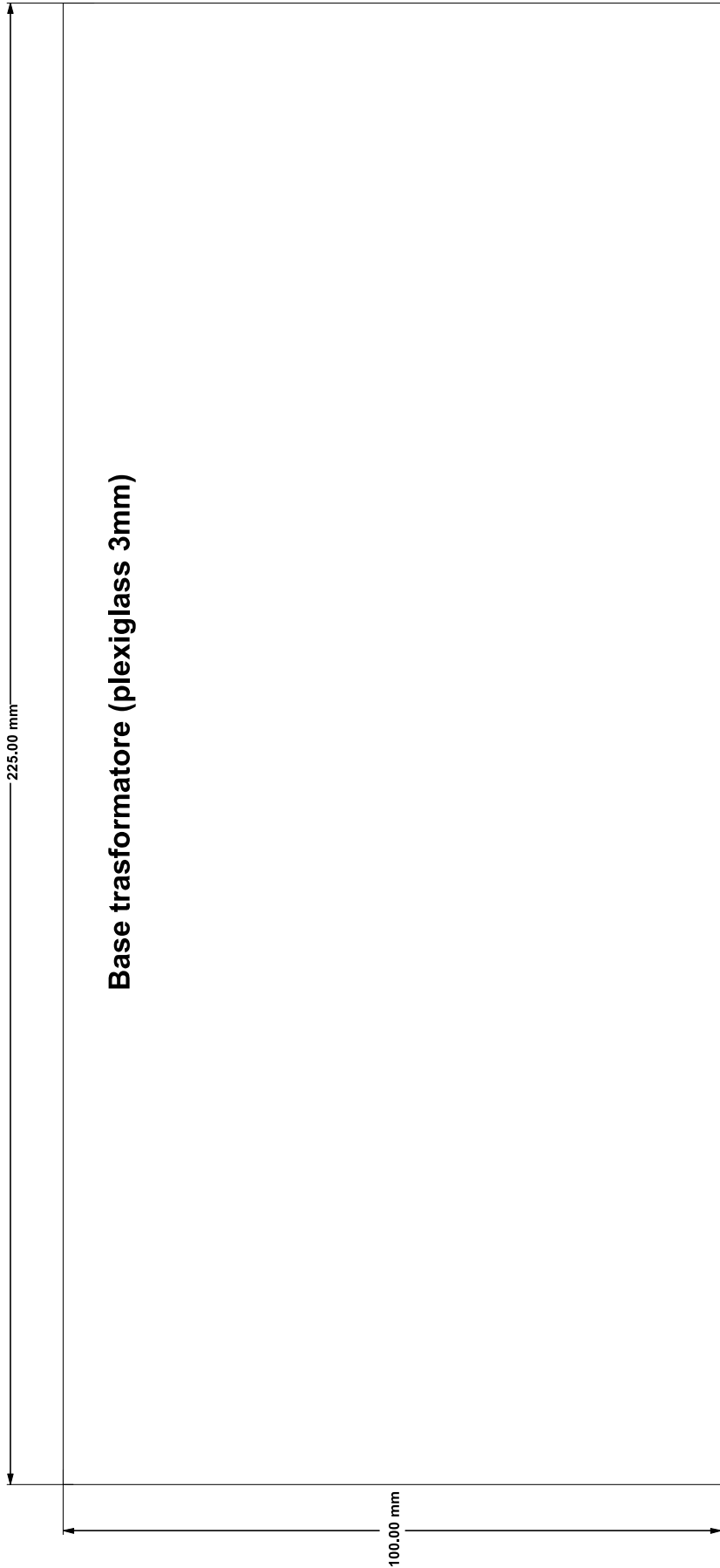

EXT

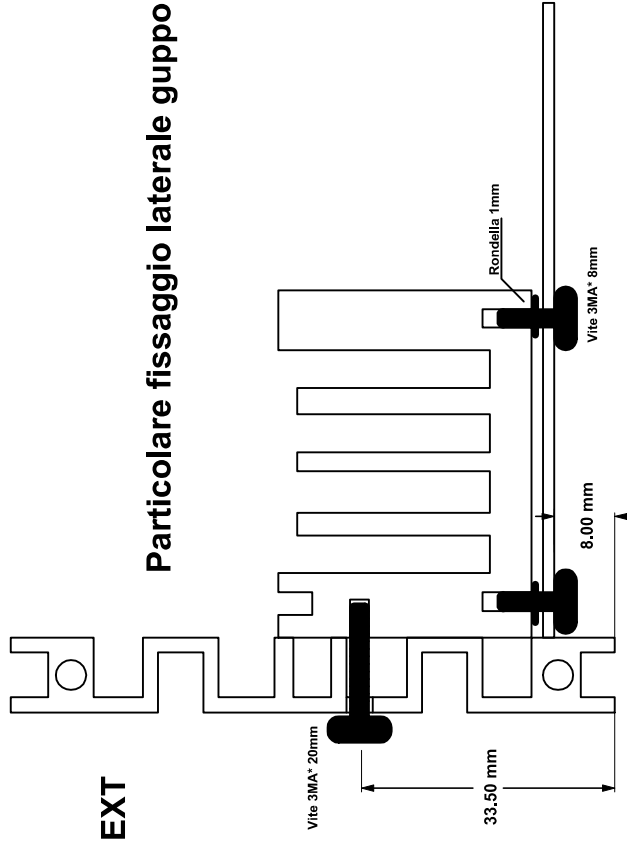

Particolare fissaggio laterale guppo dissipatore/scheda

EXT

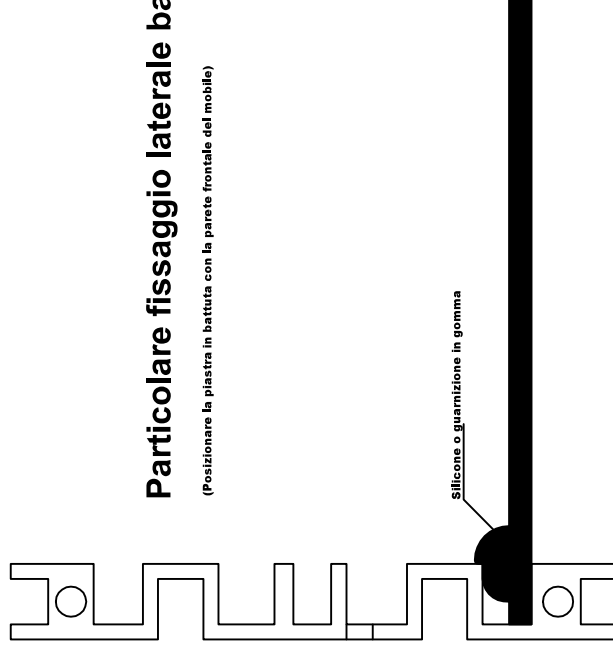

Particolare fissaggio laterale base trafo

(Posizionare la piastra in battuta con la parete frontale del mobile)